

TPS5410EVM-203 1-A, SWIFT™ Regulator Evaluation Module

Contents

1	Introduction	2
2	Test Setup and Results	4
3	Board Layout	13
4	Schematic and Bill of Materials	17

List of Figures

1	TPS5410 12 V Output Efficiency	5
2	TPS5410 5 V Output Efficiency	6
3	TPS5410 12 V Output Load Regulation	6
4	TPS5410 5 V Output Load Regulation	7
5	TPS5410 12 V Output Line Regulation	7
6	TPS5410 5 V Output Line Regulation	8
7	TPS5410 12 V Output Transient Response	8
8	TPS5410 5 V Output Transient Response	9
9	TPS5410 12 V Output Loop Response	9
10	TPS5410 5 V Output Loop Response	10
11	TPS5410 12 V Output Ripple	10
12	TPS5410 5 V Output Ripple	11
13	TPS5410 12 V Input Ripple	11
14	TPS5410 5 V Input Ripple	12
15	TPS5410 Start-Up, ENA and V_O	12
16	Startup Waveform, V_I and V_O	13
17	Top-Side Layout	14
18	Bottom-Side Layout (Looking From Top Side)	15
19	Top-Side Assembly	16
20	TPS5410EVM-203 Schematic	17

List of Tables

1	Input Voltage and Output Current Summary	2
2	TPS5410EVM-203 Performance Specification Summary	2
3	Output Voltages Available	3
4	EVM Connectors and Test Points	5
5	Bill of Materials	18

1 Introduction

This user's guide contains background information for the TPS5410 as well as support documentation for the TPS5410EVM-203 evaluation module (HPA203). Also included are the performance specifications, the schematic, and the bill of materials for the TPS5410EVM-203.

1.1 Background

The TPS5410 dc/dc converter is designed to provide up to a 1-A output from an input voltage source of 5.5 V to 36 V. The TPS5410EVM-203 is designed using 2 independent circuits providing output voltages of 12 V and 5 V. Rated input voltage and output current range for the evaluation module is given in [Table 1](#). This evaluation module is configured to demonstrate the flexibility of the TPS5410 regulators. The switching frequency is internally set at a nominal 500 kHz. The high-side MOSFET is incorporated inside the TPS5410 package along with the gate drive circuitry. The low drain-to-source on resistance of the MOSFET allows the TPS5410 to achieve high efficiencies and helps keep the junction temperature low at high output currents. The compensation components are provided internal to the integrated circuit (IC), whereas an external divider allows for an adjustable output voltage. Additionally, the TPS5430/31 provides an enable input. The absolute maximum input voltage is 40 V for the TPS5410EVM-203.

Table 1. Input Voltage and Output Current Summary

OUTPUT VOLTAGE	INPUT VOLTAGE RANGE	OUTPUT CURRENT RANGE
12 V	V _{IN} = 14.5 V to 36 V	0 A to 1 A
5 V	V _{IN} = 7 V to 36 V	0 A to 1 A

1.2 Performance Specification Summary

A summary of the TPS5410EVM-203 performance specifications is provided in [Table 2](#). Specifications are given for an input voltage of V_{IN} = 25 V and an output voltage of 12 V or 5 V, unless otherwise specified. The TPS5410EVM-203 is designed and tested for V_{IN} = 14.5 V to 36 V for the 12 V circuit and V_{IN} = 7 V to 36 V for the 5 V circuit. The ambient temperature is 25°C for all measurements, unless otherwise noted.

Table 2. TPS5410EVM-203 Performance Specification Summary

SPECIFICATION		TEST CONDITIONS	MIN	TYP	MAX	UNIT
V _{IN} voltage range	12 V output		14.5		36	V
	5 V output		7		36	
Output voltage set point	12 V output			12.0		V
	5 V output			5.0		
Output current range (both circuits)			0		1	A
Line regulation	12 V output	I _O = 0.5 A, V _{IN} = 14.5 V – 36 V		±0.05%		
	5 V output	I _O = 0.5 A, V _{IN} = 3 V – 36 V		±0.09%		
Load regulation	12 V output	V _{IN} = 25 V, I _O = 0 A to 1 A		±0.03%		
	5 V output			±0.03%		
Load transient response	12 V output	I _O = 0.25 A to 0.75 A	Voltage change	-110		mV
			Recovery time	150		µs
	5 V output		Voltage change	-70		mV
			Recovery time	200		µs
	12 V output	I _O = 0.25 A to 0.75 A	Voltage change	110		mV
			Recovery time	150		µs
5 V output	Voltage change		70		mV	
	Recovery time		200		µs	
Loop bandwidth	12 V output	V _{IN} = 25 V, I _O = 0.5 A		10		kHz
	5 V output	V _{IN} = 25 V, I _O = 0.5 A		17		

Table 2. TPS5410EVM-203 Performance Specification Summary (continued)

SPECIFICATION		TEST CONDITIONS	MIN	TYP	MAX	UNIT
Phase margin	12 V output	V _{IN} = 25 V, I _O = 0.5 A		60		°
	5 V output	V _{IN} = 25 V, I _O = 0.5 A		71		
Input ripple voltage	12 V output	I _O = 1 A		180		mVpp
	5 V output			50		
Output ripple voltage	12 V output	I _O = 1 A		15		mVpp
	5 V output			8		
Output rise time				8		ms
Operating frequency				500		kHz
Max efficiency	12 V output	V _{IN} = 14.5 V, V _O = 12 V, I _O = 0.8 A		96.3%		
	5 V output	V _{IN} = 7 V, V _O = 5 V, I _O = 0.4 A		94.3%		

1.3 Modifications

These evaluation modules are designed to demonstrate the small size that can be attained when designing with the TPS5410. A few changes can be made to this module.

1.3.1 Output Voltage Set Point

To change the output voltage of the EVM, it is necessary to change the value of resistor R3 (12 V circuit) or R4 (5 V circuit). Changing the value of these resistors can change the output voltage above 1.25 V. The value of R for a specific output voltage can be calculated using [Equation 1](#).

$$R2 = 10 \text{ k}\Omega \times \frac{1.221 \text{ V}}{V_O - 1.221 \text{ V}} \quad (1)$$

[Table 3](#) lists the R values for some common output voltages. Note that V_{IN} must be in a range so that the minimum on-time is greater than 200 ns, and the maximum duty cycle is less than 87%. The values given in [Table 3](#) are standard values, not the exact value calculated using [Equation 1](#).

Table 3. Output Voltages Available

Output Voltage (V)	R ₂ Value (kΩ)
1.8	21.5
2.5	9.53
3.3	5.90
5	3.24

1.3.2 External Compensation

The TPS5410 utilizes an internally synthesized type 3 compensation network. As this compensation network is fixed, it is ideally suited for a limited range of output filter components. Both the 12 V and 5 V circuits contain additional component locations that allow the overall loop characteristics of the circuits to be modified so that output filter capacitors that would normally not be useable can be accommodated. These components are C6, C9, C12 and R1 for the 12 V circuit and C5, C10, C13 and R2 for the 5 V circuit. These components can be used to place two additional pole / zero pairs into the feedback loop. Also present are 0 Ω resistors, R5 and R7, in the feedback path of each circuit. These maybe removed to break the loop to verify the loop response if modifications are made.

The 12 V circuit on the EVM is designed using as standard type of output filter that works well with the internal compensation. The external compensation components C6, C9, C12 and R1 are left open. The 5 V circuit is designed to use ceramic output capacitors. The external compensation components are required for this design and are populated as shown in the schematic of [Figure 20](#). For additional information on designing with ceramic or aluminum electrolytic capacitors using the TPS5410 or other

wide voltage range SWIFT devices, see [SLVA237 Using TPS5410/20/30/31 With Aluminum/Ceramic Output Capacitors](#). It should be noted that for this design the value of the output capacitors was derated by 70 percent to account for the reduced capacitance of ceramic capacitors that have a bias voltage applied. Also, C5 is added to the circuit to improve load regulation performance. If the circuit is modified for different pole / zero locations, C5 should be chosen to be less than 1/10 the value of C13.

2 Test Setup and Results

This section describes how to properly connect, set up, and use the TPS5410EVM-203 evaluation module. The section also includes test results typical for the evaluation modules and covers efficiency, output voltage regulation, load transients, loop response, output ripple, input ripple, and startup.

2.1 Input / Output Connections

The TPS5410EVM-203 is provided with input/output connectors and test points as shown in [Table 4](#). A power supply capable of supplying 1 A should be connected to J1 and J2 for the 12 V circuit or J3 and J4 for the 5 V circuit. If both circuits are powered from the same supply, make sure that the supply is capable of supplying the full current for both circuits. The load should be connected to J5 and J6 for the 12 V output, and J7 and J8 for the 5 V output. Connections should be made using short lengths of 20 AWG wires or better to avoid losses. The maximum load current capability should be 1 A for each circuit. Each of the input and output connectors provides two pins, one for the intended connection and one provides Kelvin connection point to monitor the input and output voltages.

Table 4. EVM Connectors and Test Points

Reference Designator	Function
J1	VIN for 12 V circuit (see Table 1 for Vin range)
J2	GND return for 12 V circuit VIN
J3	VIN for 5 V circuit (see Table 1 for Vin range)
J4	GND return for 5 V circuit VIN
J5	12 V output
J6	GND return for 12 V output
J7	5 V output
J8	GND return for 5 V output
JP1	2-pin header for enable of 5 V output. Connect EN to ground to disable, open to enable.
JP2	2-pin header for enable of 12 V output. Connect EN to ground to disable, open to enable.
TP1	PH node of 5 V circuit
TP2	PH node of 12 V circuit
TP3	VSENSE node of 12 V output
TP4	VSENSE node of 5 V output
TP5	Test point between voltage divider network and R5. Used for loop response measurements of 12 V circuit.
TP6	Test point between voltage divider network and R7. Used for loop response measurements of 5 V circuit.

2.2 Efficiency

The efficiency for both EVM output voltages peak at a load current of about 0.75 A, and then decrease as the load current increases towards full load. Figure 1 shows the efficiency for the 12 V output at an ambient temperature of 25°C.

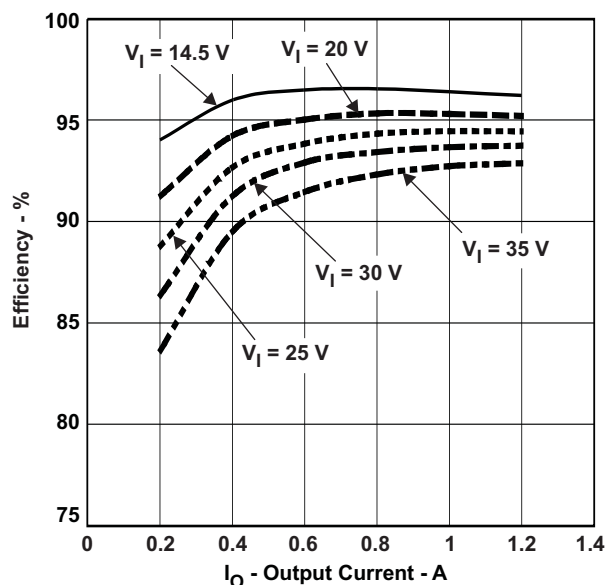

Figure 1. TPS5410 12 V Output Efficiency

Figure 2 shows the efficiency for the 5 V output at an ambient temperature of 25°C.

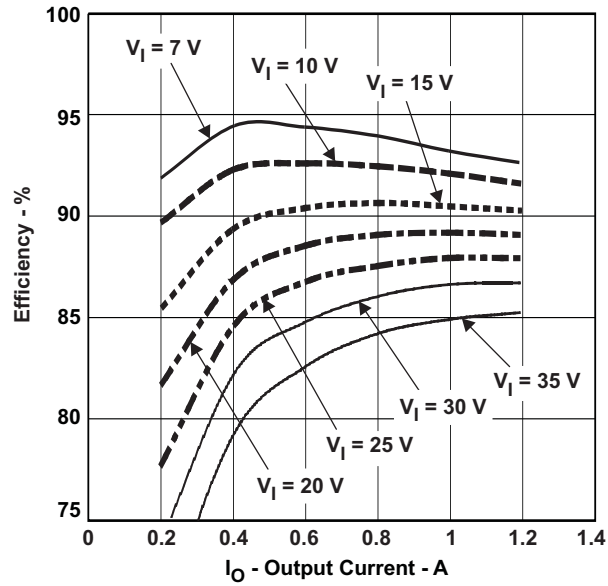

Figure 2. TPS5410 5 V Output Efficiency

The efficiency is lower at higher ambient temperatures, due to temperature variation in the drain-to-source resistance of the MOSFETs.

2.3 Output Voltage Load Regulation

The load regulation for the 12 V and 5 V outputs are shown in Figure 3 and Figure 4.

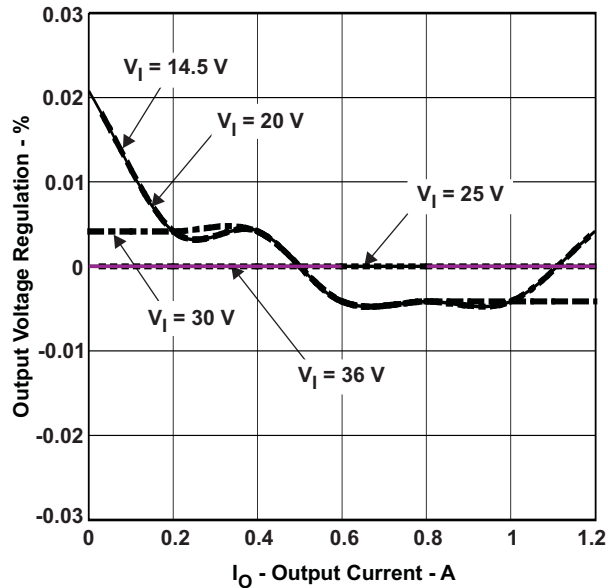

Figure 3. TPS5410 12 V Output Load Regulation

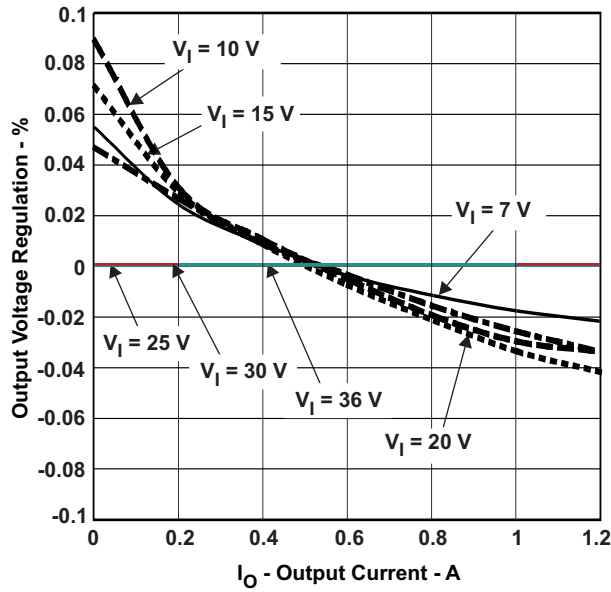

Figure 4. TPS5410 5 V Output Load Regulation

Measurements are given for an ambient temperature of 25°C.

2.4 Output voltage Line Regulation

The line regulation for the 12 V and 5 V outputs are shown in [Figure 5](#) and [Figure 6](#).

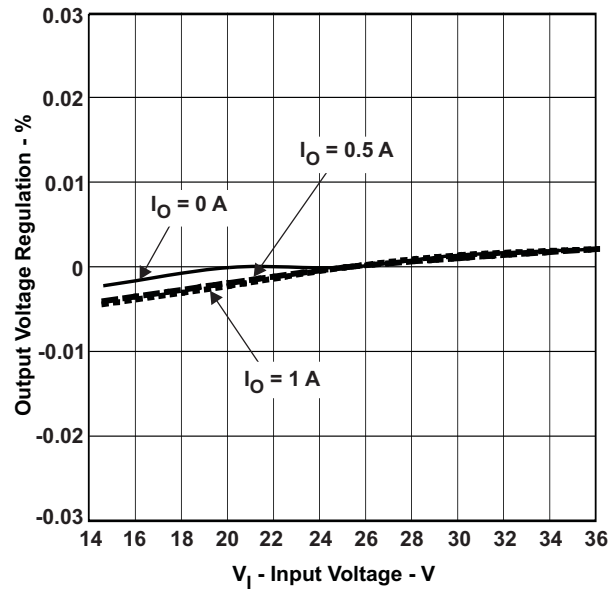

Figure 5. TPS5410 12 V Output Line Regulation

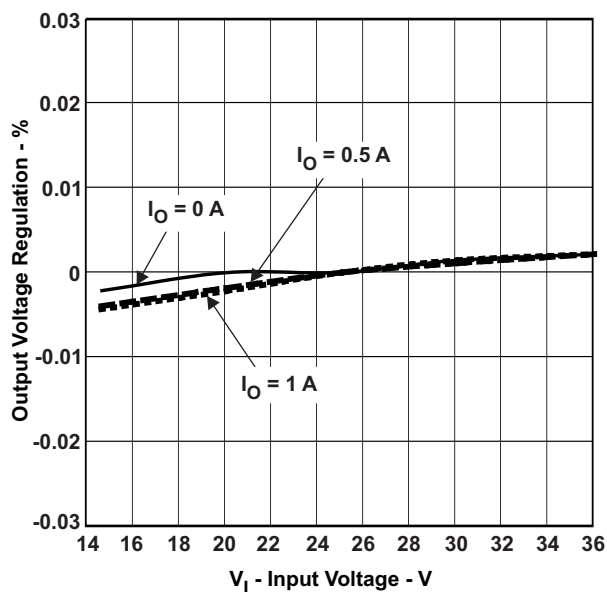

Figure 6. TPS5410 5 V Output Line Regulation

2.5 Load Transients

The 12 V and 5 V circuit response to load transients is shown in Figure 7 and Figure 8. The current step is from 25% to 75% of maximum rated load. Total peak-to-peak voltage variation is as shown, including ripple and noise on the output.

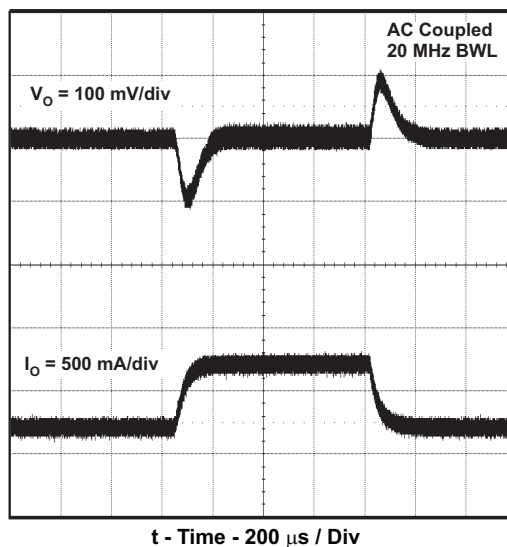

Figure 7. TPS5410 12 V Output Transient Response

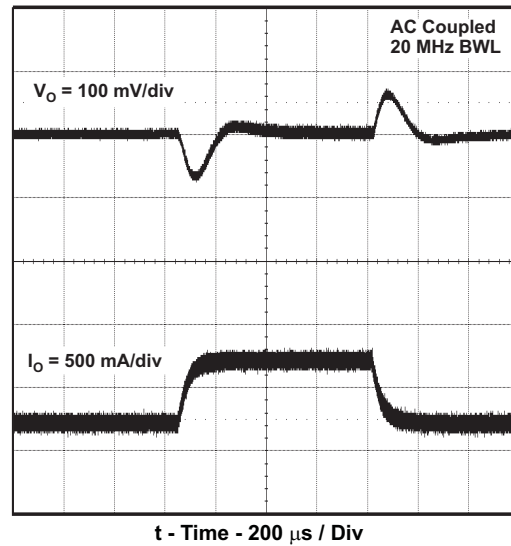

Figure 8. TPS5410 5 V Output Transient Response

2.6 Loop Characteristics

The 12 V and 5 V output loop-response characteristics are shown in Figure 9 and Figure 10. Gain and phase plots are shown for VIN voltage of 25 V. Load current for both measurements is 0.5 A.

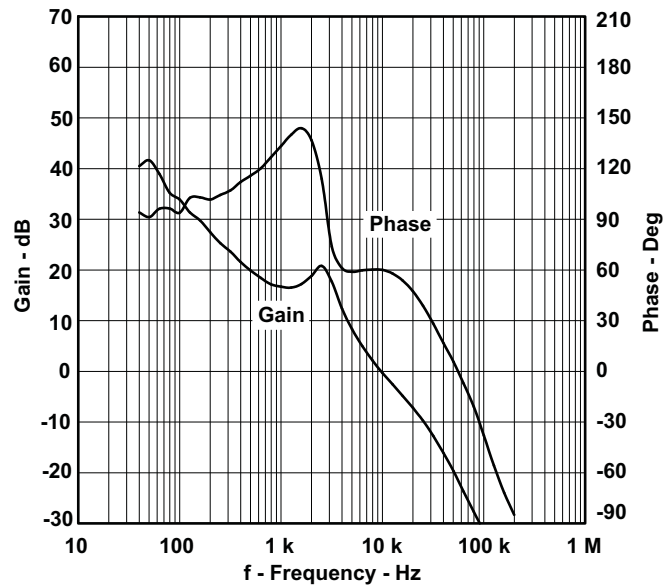

Figure 9. TPS5410 12 V Output Loop Response

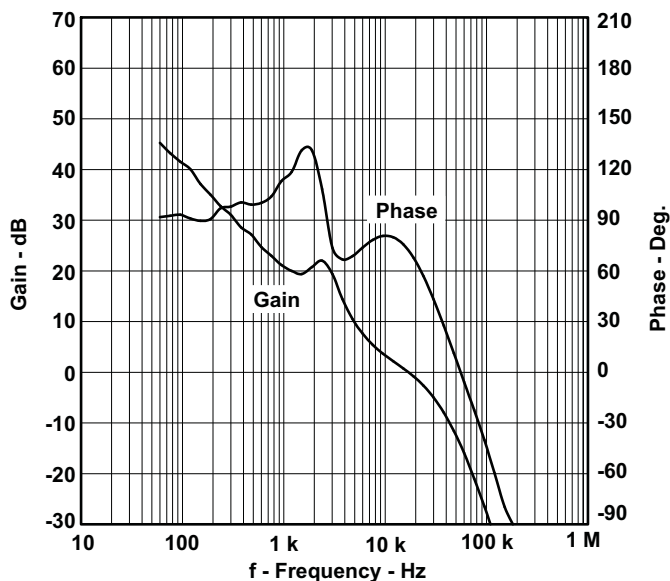

Figure 10. TPS5410 5 V Output Loop Response

2.7 Output Voltage Ripple

The 12 V and 5 V output voltage ripple is shown in Figure 11 and Figure 12. The output current is the rated full load of 1 A. Voltage is measured directly across output capacitors.

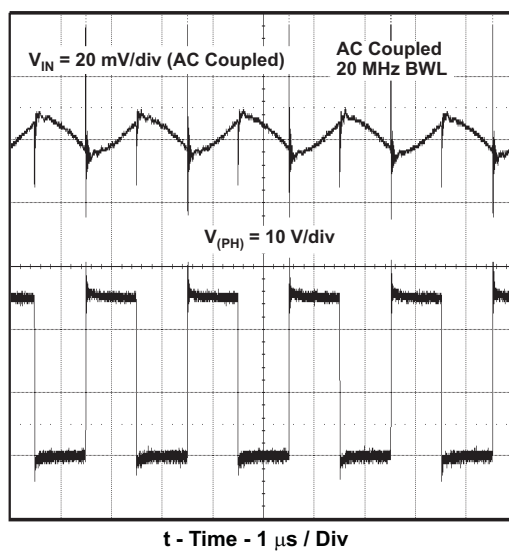

Figure 11. TPS5410 12 V Output Ripple

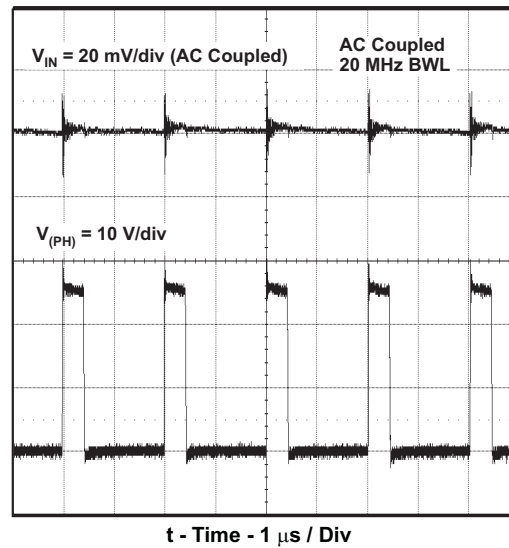

Figure 12. TPS5410 5 V Output Ripple

2.8 Input Voltage Ripple

The 12 V and 5 V input voltage ripple is shown in [Figure 13](#) and [Figure 14](#). The output current for each device is at full rated load of 1 A.

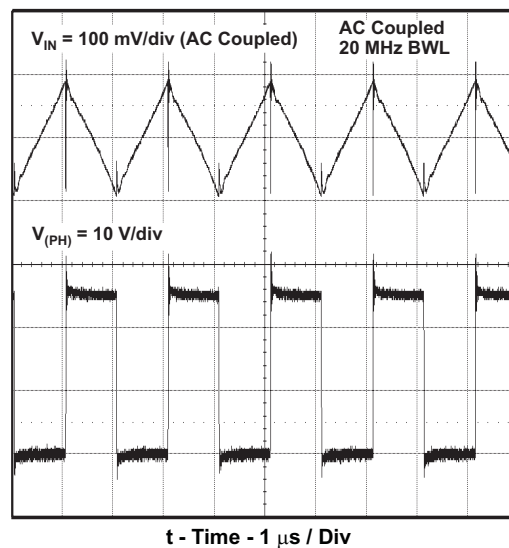
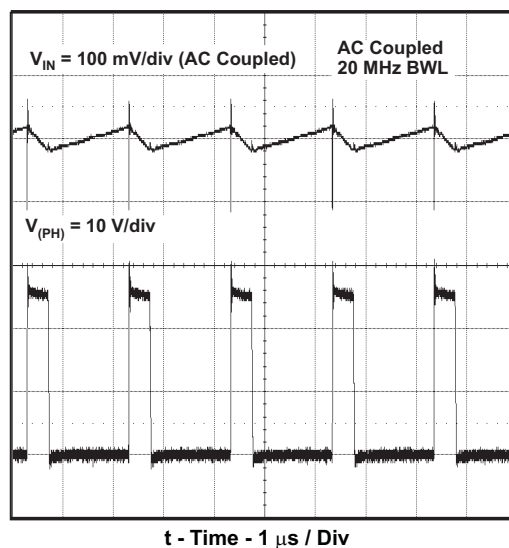
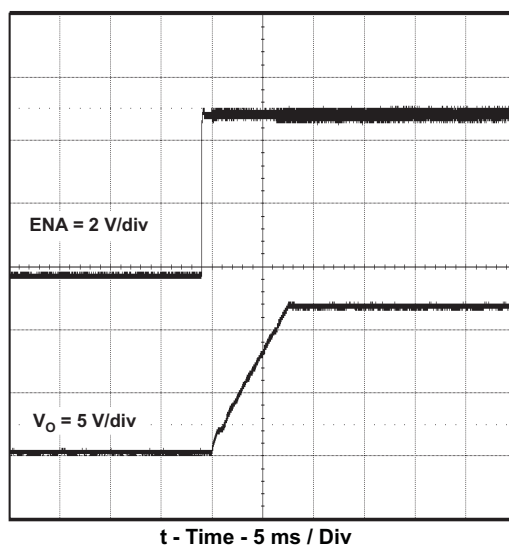

Figure 13. TPS5410 12 V Input Ripple

Figure 14. TPS5410 5 V Input Ripple

2.9 Powering Up

The start-up waveforms are shown in [Figure 15](#) and [Figure 16](#). In [Figure 15](#), the top trace shows ENA, and the bottom trace shows V_{out} for the 12 V circuit. Initially, the output is inhibited by using a jumper at JP2 to tie ENA to GND. When the jumper is removed, ENA is released. When the ENA voltage reaches the enable-threshold voltage of 1.06 V, the start-up sequence begins and the internal reference voltage begins to ramp up at the internally set rate towards 1.221 V and the output voltage ramps up to the externally set value of 12 V. [Figure 16](#) shows the start-up waveform relative to the input voltage. With the ENA pin open, the input voltage is applied to the circuit. When the UVLO threshold is reached, the start up sequence begins and the internal reference voltage begins to ramp up at the internally set rate towards 1.221 V and the output voltage ramps up to the externally set value of 12 V. The start up waveforms are similar for the 5 V circuit.

Figure 15. TPS5410 Start-Up, ENA and V_O

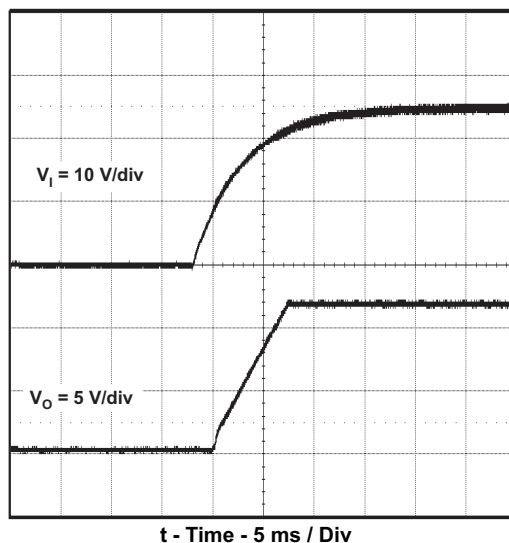

Figure 16. Startup Waveform, V_I and V_O

3 Board Layout

This section provides a description of the TPS5410EVM-203 board layout and layer illustrations.

3.1 Layout

The board layout for the TPS5410EVM-203 is shown in [Figure 17](#) through [Figure 19](#). The topside layer of the EVM is laid out in a manner typical of a user application. The top and bottom layers are 2-oz. copper.

The top layer contains the main power traces for VOUT, and VPH for both circuits. Also on the top layer are connections for the remaining pins of each TPS5410 and a large ground traces. The bottom layer contains the input voltage traces, routes for the ENA feature and VSENSE traces for both circuits. Although the two circuits are independent, the ground traces are connected together with a trace on the top side.

The input decoupling capacitors (C1 and C2) and bootstrap capacitors (C3 and C4) are all located as close to the IC as possible. In addition, the voltage set-point resistor divider components are also kept close to the IC. The voltage divider network ties to the output voltage at the point of regulation, the copper Vout trace at the output connector.

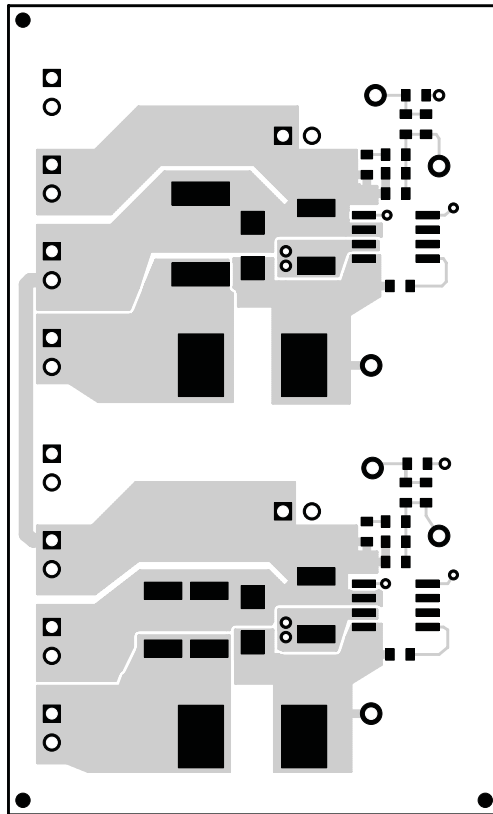

Figure 17. Top-Side Layout

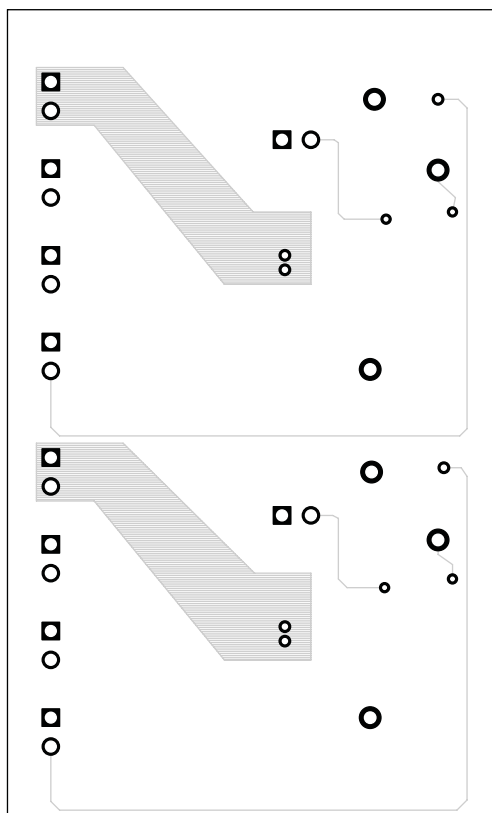

Figure 18. Bottom-Side Layout (Looking From Top Side)

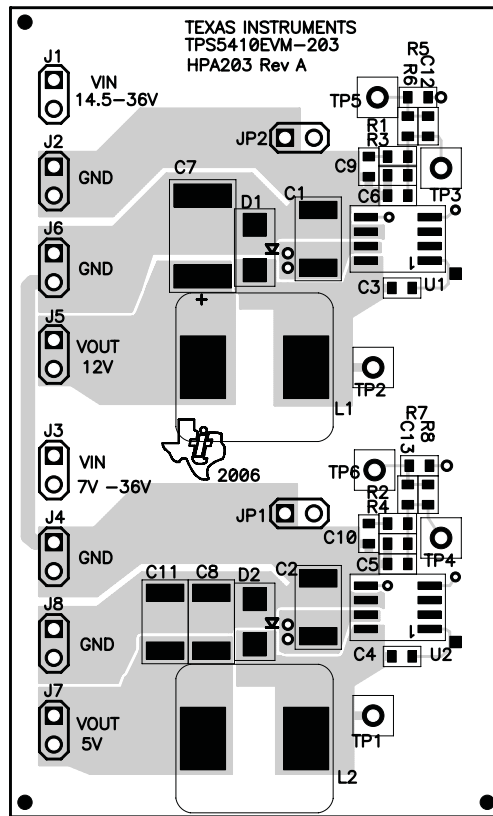

Figure 19. Top-Side Assembly

4 Schematic and Bill of Materials

The TPS5410EVM-203 and TPS5431EVM-173 schematic and bill of materials are presented in this section.

4.1 Schematic

The schematic for the TPS5410EVM-203 is shown in Figure 20.

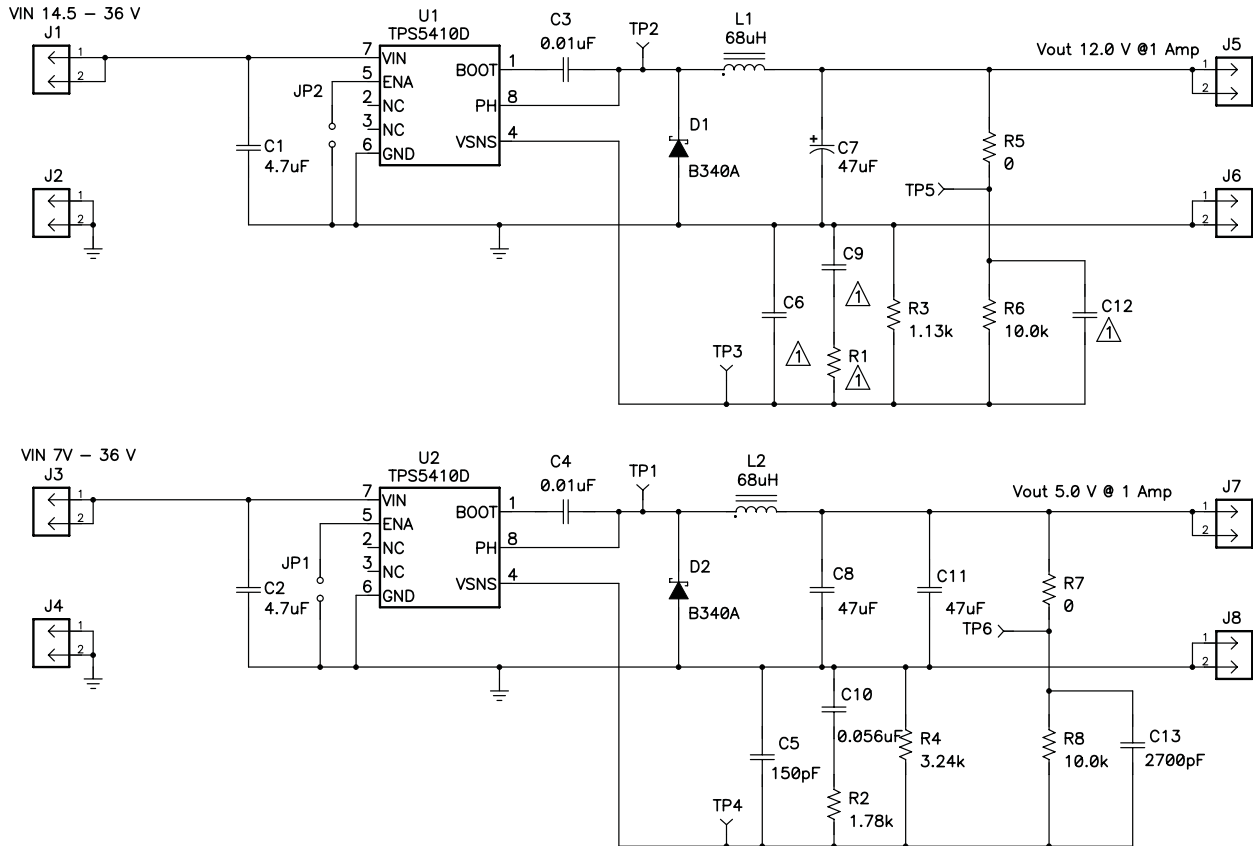

(1) Not used.

Figure 20. TPS5410EVM-203 Schematic

4.2 Bill of Materials

The bill of materials for the TPS5410EVM-203 is given by [Table 5](#).

Table 5. Bill of Materials

HPA203A BOM						
COUNT	RefDes	Value	DESCRIPTION	SIZE	Part Number	MFR
2	C1, C2	4.7uF	Capacitor, Ceramic, 50V, X5R, 20%	1812	C4532X5R1H475MT	TDK
1	C10	0.056uF	Capacitor, Ceramic, 25V, X7R, 10%	0603	ECJ-1VB1E563K	Panasonic
1	C13	2700pF	Capacitor, Ceramic, 50V, C0G, 5%	0603	C1608C0G1H272J	TDK
2	C3, C4	0.01uF	Capacitor, Ceramic, 50V, X7R, 10%	0603	C1608X7R1H103K	TDK
1	C5	150pF	Capacitor, Ceramic, 50V, C0G, 5%	0603	C1608C0G1H151J	TDK
0	C6, C9, C12	Open	Capacitor, Ceramic, xxV	0603		
1	C7	47uF	Capacitor, Tantalum, 20V,	7343 (D)	TPSE476M020R0150	AVX
2	C8, C11	47uF	Capacitor, Ceramic, 10V, X5R, 20%	1812	C4532X5R1A476MT	TDK
2	D1, D2		Diode, Schottky, 3A, 40V	SMA	B340A	Diodes Inc
8	J1- J8		Header, 2 pin, 100mil spacing, (36-pin strip)	0.100 x 2	PTC36SAAN	
2	JP1, JP2		Header, 2 pin, 100mil spacing, (36-pin strip)	0.100 x 2	PTC36SAAN	Sullins
2	L1, L2	68uH	Inductor, SMT, 2.3A, 130milliohm	0.484 x 0.484	MSS1260-683MLB	Coilcraft
0	R1	Open	Resistor, Chip, 1/16W, yy%	0603		
1	R2	1.78k	Resistor, Chip, 1/16W, 1%	0603	Std	Std
1	R3	1.13k	Resistor, Chip, 1/16W, 1%	0603	Std	Std
1	R4	3.24k	Resistor, Chip, 1/16W, 1%	0603	Std	Std
2	R5, R7	0	Resistor, Chip, 1/16W, 5%	0603	Std	Std
2	R6, R8	10.0k	Resistor, Chip, 1/16W, 1%	0603	Std	Std
6	TP1 - TP6		Test Point, Red, Thru Hole Color Keyed	0.100 x 0.100	5000	Keystone
2	U1, U2		IC, Switching Step-Down Regulator, 5.5V-36V, 1A	SO8	TPS5410D	TI
1	--		PCB, 2.8 In x 1.7 In x 0.062 In		HPA203	Any
2	--		Shunt, 100mil, Black	0.100	929950-00	3M

Table 5. Bill of Materials (continued)

EVALUATION BOARD/KIT IMPORTANT NOTICE

Texas Instruments (TI) provides the enclosed product(s) under the following conditions:

This evaluation board/kit is intended for use for **ENGINEERING DEVELOPMENT, DEMONSTRATION, OR EVALUATION PURPOSES ONLY** and is not considered by TI to be a finished end-product fit for general consumer use. Persons handling the product(s) must have electronics training and observe good engineering practice standards. As such, the goods being provided are not intended to be complete in terms of required design-, marketing-, and/or manufacturing-related protective considerations, including product safety and environmental measures typically found in end products that incorporate such semiconductor components or circuit boards. This evaluation board/kit does not fall within the scope of the European Union directives regarding electromagnetic compatibility, restricted substances (RoHS), recycling (WEEE), FCC, CE or UL, and therefore may not meet the technical requirements of these directives or other related directives.

Should this evaluation board/kit not meet the specifications indicated in the User's Guide, the board/kit may be returned within 30 days from the date of delivery for a full refund. **THE FOREGOING WARRANTY IS THE EXCLUSIVE WARRANTY MADE BY SELLER TO BUYER AND IS IN LIEU OF ALL OTHER WARRANTIES, EXPRESSED, IMPLIED, OR STATUTORY, INCLUDING ANY WARRANTY OF MERCHANTABILITY OR FITNESS FOR ANY PARTICULAR PURPOSE.**

The user assumes all responsibility and liability for proper and safe handling of the goods. Further, the user indemnifies TI from all claims arising from the handling or use of the goods. Due to the open construction of the product, it is the user's responsibility to take any and all appropriate precautions with regard to electrostatic discharge.

EXCEPT TO THE EXTENT OF THE INDEMNITY SET FORTH ABOVE, NEITHER PARTY SHALL BE LIABLE TO THE OTHER FOR ANY INDIRECT, SPECIAL, INCIDENTAL, OR CONSEQUENTIAL DAMAGES.

TI currently deals with a variety of customers for products, and therefore our arrangement with the user **is not exclusive.**

TI assumes **no liability for applications assistance, customer product design, software performance, or infringement of patents or services described herein.**

Please read the User's Guide and, specifically, the Warnings and Restrictions notice in the User's Guide prior to handling the product. This notice contains important safety information about temperatures and voltages. For additional information on TI's environmental and/or safety programs, please contact the TI application engineer or visit www.ti.com/esh.

No license is granted under any patent right or other intellectual property right of TI covering or relating to any machine, process, or combination in which such TI products or services might be or are used.

FCC Warning

This evaluation board/kit is intended for use for **ENGINEERING DEVELOPMENT, DEMONSTRATION, OR EVALUATION PURPOSES ONLY** and is not considered by TI to be a finished end-product fit for general consumer use. It generates, uses, and can radiate radio frequency energy and has not been tested for compliance with the limits of computing devices pursuant to part 15 of FCC rules, which are designed to provide reasonable protection against radio frequency interference. Operation of this equipment in other environments may cause interference with radio communications, in which case the user at his own expense will be required to take whatever measures may be required to correct this interference.

EVM WARNINGS AND RESTRICTIONS

It is important to operate this EVM within the input voltage range and the output current range specified in Table 1.

Exceeding the specified input range may cause unexpected operation and/or irreversible damage to the EVM. If there are questions concerning the input range, please contact a TI field representative prior to connecting the input power.

Applying loads outside of the specified output range may result in unintended operation and/or possible permanent damage to the EVM. Please consult the EVM User's Guide prior to connecting any load to the EVM output. If there is uncertainty as to the load specification, please contact a TI field representative.

During normal operation, some circuit components may have case temperatures greater than 55°C. The EVM is designed to operate properly with certain components above 60°C as long as the input and output ranges are maintained. These components include but are not limited to linear regulators, switching transistors, pass transistors, and current sense resistors. These types of devices can be identified using the EVM schematic located in the EVM User's Guide. When placing measurement probes near these devices during operation, please be aware that these devices may be very warm to the touch.

IMPORTANT NOTICE

Texas Instruments Incorporated and its subsidiaries (TI) reserve the right to make corrections, modifications, enhancements, improvements, and other changes to its products and services at any time and to discontinue any product or service without notice. Customers should obtain the latest relevant information before placing orders and should verify that such information is current and complete. All products are sold subject to TI's terms and conditions of sale supplied at the time of order acknowledgment.

TI warrants performance of its hardware products to the specifications applicable at the time of sale in accordance with TI's standard warranty. Testing and other quality control techniques are used to the extent TI deems necessary to support this warranty. Except where mandated by government requirements, testing of all parameters of each product is not necessarily performed.

TI assumes no liability for applications assistance or customer product design. Customers are responsible for their products and applications using TI components. To minimize the risks associated with customer products and applications, customers should provide adequate design and operating safeguards.

TI does not warrant or represent that any license, either express or implied, is granted under any TI patent right, copyright, mask work right, or other TI intellectual property right relating to any combination, machine, or process in which TI products or services are used. Information published by TI regarding third-party products or services does not constitute a license from TI to use such products or services or a warranty or endorsement thereof. Use of such information may require a license from a third party under the patents or other intellectual property of the third party, or a license from TI under the patents or other intellectual property of TI.

Reproduction of information in TI data books or data sheets is permissible only if reproduction is without alteration and is accompanied by all associated warranties, conditions, limitations, and notices. Reproduction of this information with alteration is an unfair and deceptive business practice. TI is not responsible or liable for such altered documentation.

Resale of TI products or services with statements different from or beyond the parameters stated by TI for that product or service voids all express and any implied warranties for the associated TI product or service and is an unfair and deceptive business practice. TI is not responsible or liable for any such statements.

TI products are not authorized for use in safety-critical applications (such as life support) where a failure of the TI product would reasonably be expected to cause severe personal injury or death, unless officers of the parties have executed an agreement specifically governing such use. Buyers represent that they have all necessary expertise in the safety and regulatory ramifications of their applications, and acknowledge and agree that they are solely responsible for all legal, regulatory and safety-related requirements concerning their products and any use of TI products in such safety-critical applications, notwithstanding any applications-related information or support that may be provided by TI. Further, Buyers must fully indemnify TI and its representatives against any damages arising out of the use of TI products in such safety-critical applications.

TI products are neither designed nor intended for use in military/aerospace applications or environments unless the TI products are specifically designated by TI as military-grade or "enhanced plastic." Only products designated by TI as military-grade meet military specifications. Buyers acknowledge and agree that any such use of TI products which TI has not designated as military-grade is solely at the Buyer's risk, and that they are solely responsible for compliance with all legal and regulatory requirements in connection with such use.

TI products are neither designed nor intended for use in automotive applications or environments unless the specific TI products are designated by TI as compliant with ISO/TS 16949 requirements. Buyers acknowledge and agree that, if they use any non-designated products in automotive applications, TI will not be responsible for any failure to meet such requirements.

Following are URLs where you can obtain information on other Texas Instruments products and application solutions:

Products		Applications	
Amplifiers	amplifier.ti.com	Audio	www.ti.com/audio
Data Converters	dataconverter.ti.com	Automotive	www.ti.com/automotive
DSP	dsp.ti.com	Broadband	www.ti.com/broadband
Interface	interface.ti.com	Digital Control	www.ti.com/digitalcontrol
Logic	logic.ti.com	Military	www.ti.com/military
Power Mgmt	power.ti.com	Optical Networking	www.ti.com/opticalnetwork
Microcontrollers	microcontroller.ti.com	Security	www.ti.com/security
RFID	www.ti-rfid.com	Telephony	www.ti.com/telephony
Low Power Wireless	www.ti.com/lpw	Video & Imaging	www.ti.com/video
		Wireless	www.ti.com/wireless

Mailing Address: Texas Instruments, Post Office Box 655303, Dallas, Texas 75265
Copyright © 2007, Texas Instruments Incorporated